

Performance of a multi-tube, large-area helicon source

Francis F. Chen and John D. Evans
UCLA

I. Introduction

A proof-of-principle experiment has been done to show that a high density plasma covering a 40-cm diameter area uniformly can be produced with an array of helicon sources. First, a matching and distribution network was designed and tested to show that the RF power could be divided evenly among the multiple sources and that breakdown and sustainment of the discharge could be obtained. Second, different types of sources were tried, and one was found to work better than the others. Third, a rotatable **array** of ion collectors was made to show that the plasma diffused within a reasonably short distance so that the discreteness of the sources could not be detected. This concept may lead to a robust tool for processing 300-450mm wafers or arbitrarily large flat-panel displays.

2. Source configuration No. 1

The first configuration tested consisted of seven helicon sources injecting plasma into a "magnetic bucket," or processing chamber covered with a permanent magnet array to provide surface confinement, as shown in Fig. 1.

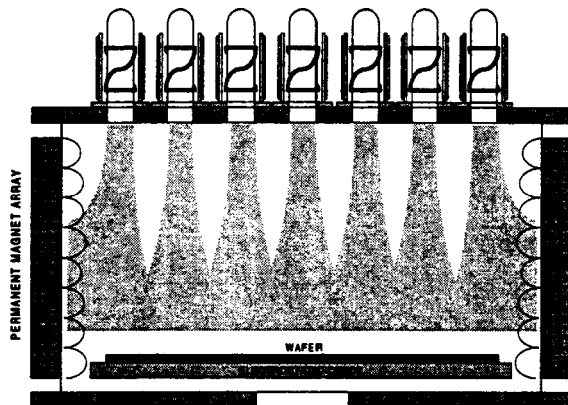

Fig. 1

Each source, shown in Fig. 2, consisted of a 2" diam tube, a helical antenna of azimuthal mode $m = 1$ symmetry, and a small solenoid producing fields B up to 100G.

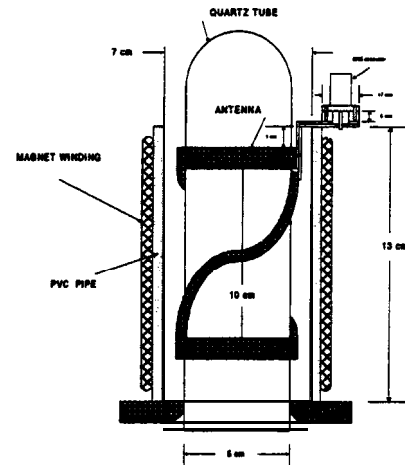

Fig. 2

The cylindrical tubes were arranged in a close-packed hexagon array, as shown in Fig. 3.

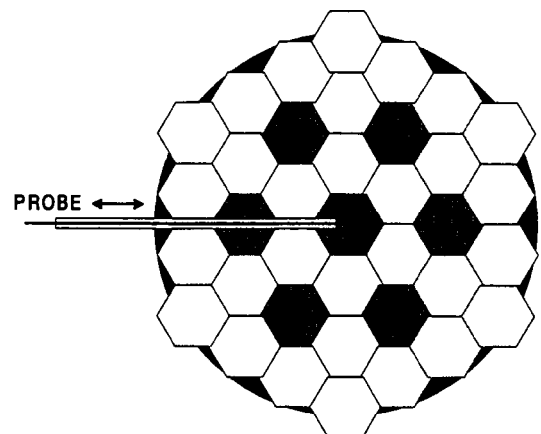

Fig. 3

A PMT **FastProbe®** was used to scan the density radially from the edge to the center at $z = 9$ and 27 cm below the top plate (Fig. 4). The discrete tube structure can be seen at 9cm but disappears by 27cm. Fig. 5 shows $n(r)$ in chlorine as B is varied.

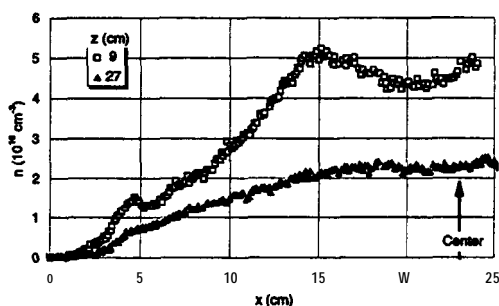

Fig. 4: 10mTorr Cl_2 , 2.5kW @ 13.56 MHz, 30G

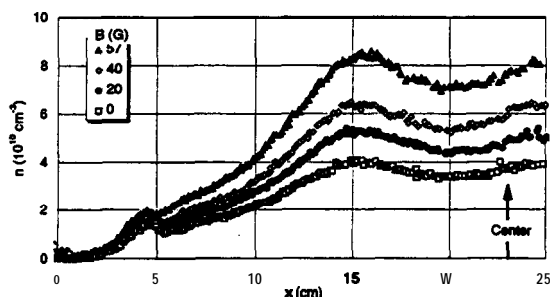

Fig. 5: 10mTorr Cl ?, 3kW @ 13.56 MHz, $z = 9\text{cm}$

Similar data in argon show higher densities at the same power and more uniform profiles. The low densities of $< 10^{11} \text{cm}^{-3}$ are not typical of helicon discharges. This is shown in Fig. 6, where $n(r=0)$ is plotted vs RF power P_{rf} . There is a single jump as the plasma changes from a weakly glowing capacitive discharge to an inductive discharge at $\sim 200\text{W}$ per tube. However, the discharge does not make a second jump into the helicon mode.

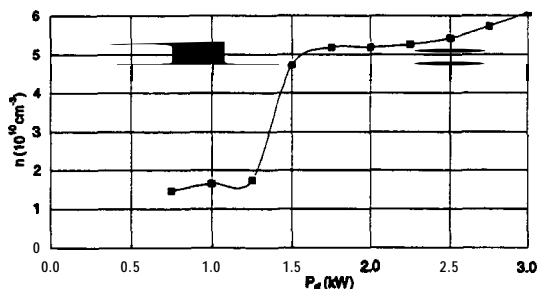

Fig. 6

Experiments with a single tube showed that doubling the length of the tube and field coil still did not produce helicon discharges. These were ICPs (Inductively Coupled Plasmas) which had the highest density at $B = 0$. However, by replacing the small solenoids

with a large field coil surrounding the whole array, bright helicon discharges whose extent depended on the direction of \mathbf{B} were obtained. A comparison using an $m = 0$ antenna and a **single** 7"-long tube is shown in Fig. 7. It is seen that the field shape makes a large **difference** in the behavior of the discharge.

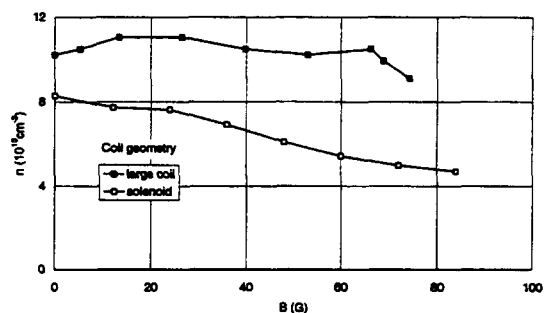

Fig. 7: 10mTorr Ar, 270W, $r = 0$, $z = 3\text{cm}$

3. Source configuration No. 2

In the next configuration, a large field coil was used, and the individual sources were changed in three ways: 1) the antenna was changed to a single $m = 0$ loop; 2) the discharge tube was shortened, as the length was no longer necessary; and 3) a dielectric "skirt" was added to keep eddy currents in the top plate from shorting out the antenna current. The source then looked like Fig. 8, except that the bucket was 12" in diameter. To measure

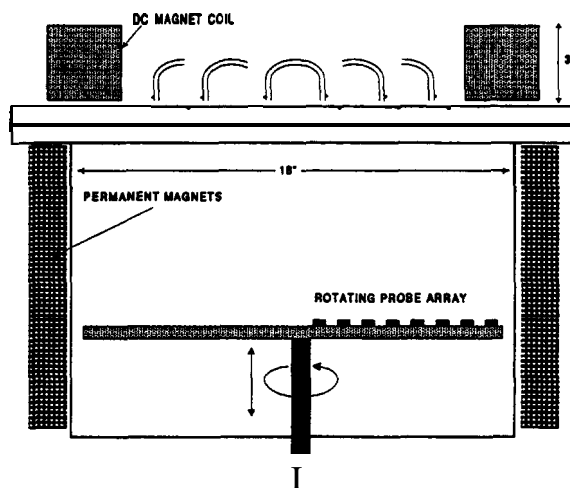

Fig. 8

the azimuthal symmetry, a radial array of ion collectors was made into a rotatable "lazysu-

san" probe. An individual source is shown in Fig. 9. To accommodate the wide skirt, the tubes were spaced farther apart, as in Fig. 10.

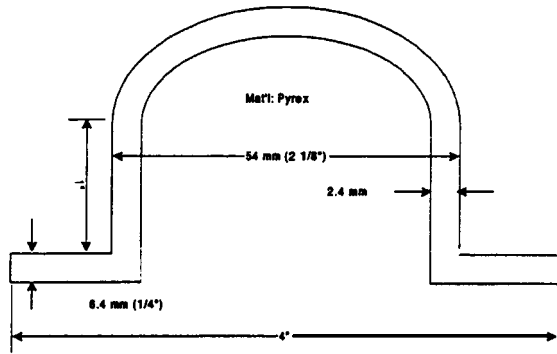

Fig. 9

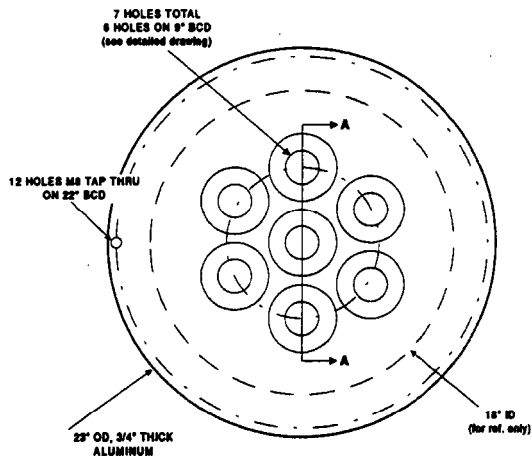

Fig. 10

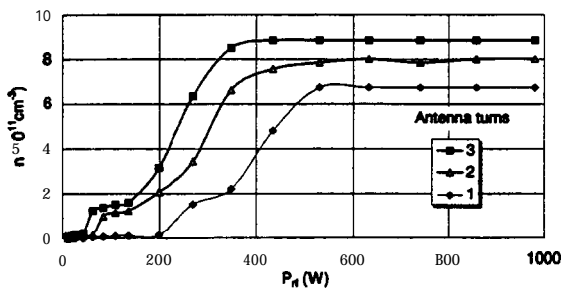

Fig. 11: 15mTorr Ar, 120G, $r = 0$, $z = 3\text{cm}$

The single-loop $m = 0$ antenna could be improved by using IV overlapping turns of wire. This increases the inductance for a better match and produces higher density at significantly lower power. The density produced by a single tube for various values of N is

shown in Fig. 11. A second jump into the **helicon** regime is seen, and n is an order of magnitude higher.

The effect of induced currents in the mounting flange could be simulated by covering the "skirt" with a ring-shaped metal plate. Fig. 12 shows results for a single tube with a 3-turn antenna.

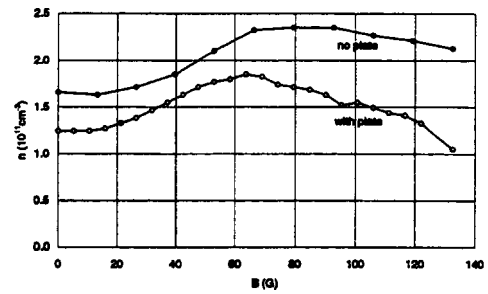

Fig. 12: 10mTorr Ar, 135W, $r = 0$, $z = 3\text{cm}$

In previous experiments, we have observed a "low-field peak" in density, which does not appear in the ICP regime. This can now be seen in source No. 2 with all seven tubes operating at a total power of 135W (Fig. 13).

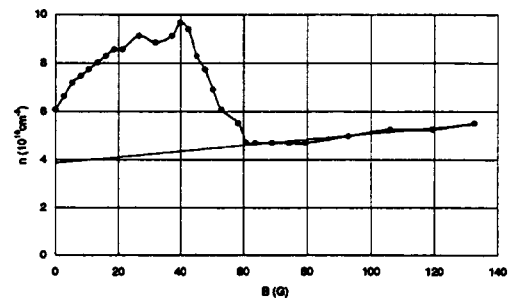

Fig. 13: 8mTorr Ar, 135W, $N = 5$, $r = 0$, $z = 3\text{cm}$

A similar peak can be seen using an array of $m = 1$ sources (Fig. 2), but only if the B-field points in the direction that launches an $m = +1$ mode downwards into the chamber. When the field is reversed so that the poorly excited $m = -1$ mode is launched downwards while the $m = +1$ mode runs into the closed end of the tube, a good discharge is obtained in the source but not in the bucket (Fig. 14).

¹F.F. Chen, X. Jiang, J.D. Evans, G. Tynan, and D. Arnush, Plasma Phys. Control. Fusion 39, A41 1 ('97).

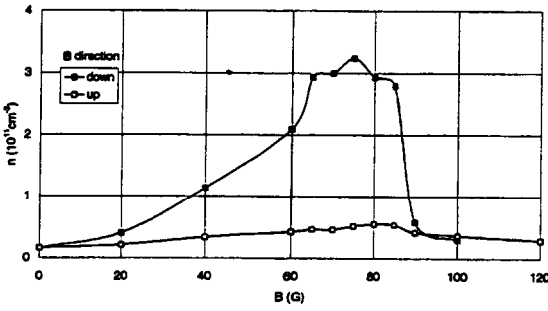

Fig. 14

Azimuthal **symmetry** of the downstream plasma in source No. 2 was measured with the lazy-Susan probe. Fig. 15 shows polar plots of $n(e)$ at $z = 20\text{cm}$ and various radii; each graph has been normalized to a unit circle, and only the variations with θ are significant. Only at the outer radii can large deviations from symmetry be seen; these arise from the surface fields of the magnetic bucket as well as from gas feed and pumping asymmetries. To compare the density at each radius,

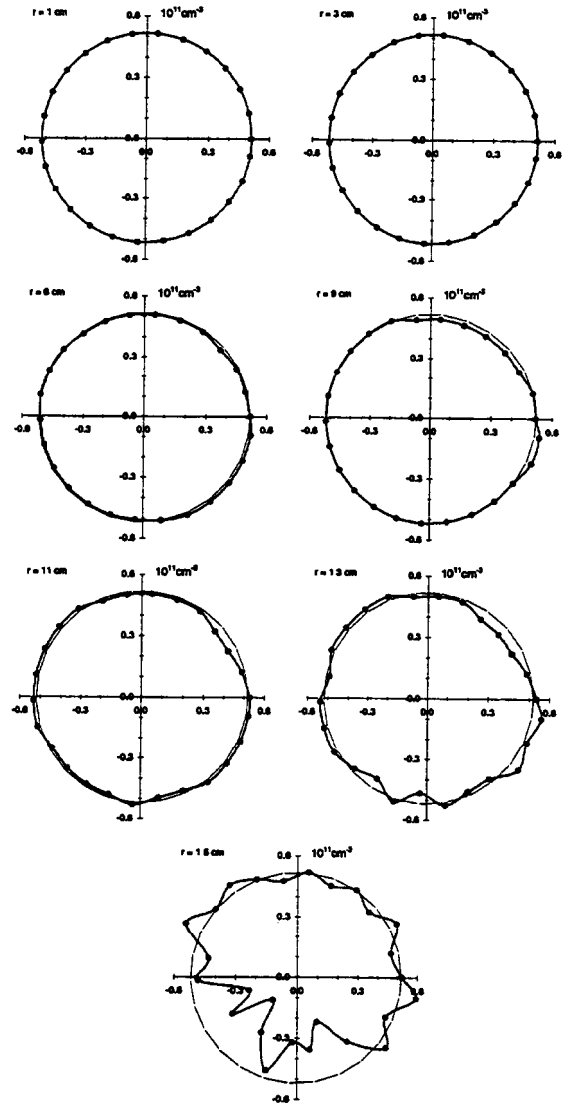

Fig. 15

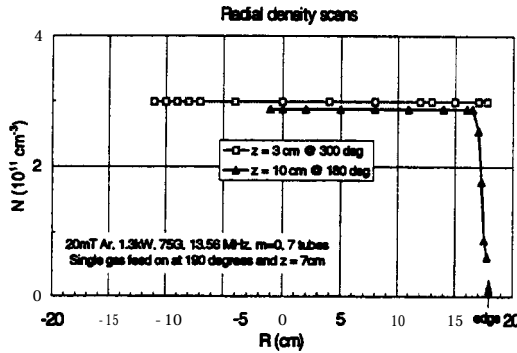

Fig. 16

was measured with a radially moving **Langmuir** probe. As seen in Fig. 16, no variation of $n(r)$ could be measured.

4. Source **configuration No. 3**

This configuration had the same sources and top plate as in Fig. 10, but the ID of the vacuum chamber was 18 inches. Density profiles at $z = 9$ and 27cm are shown in Fig. 17. With 3kW of RF power on seven tubes, a uniform plasma of nearly $2 \times 10^{12} \text{ cm}^{-3}$ density could be created over an area $>40\text{cm}$ in diameter.

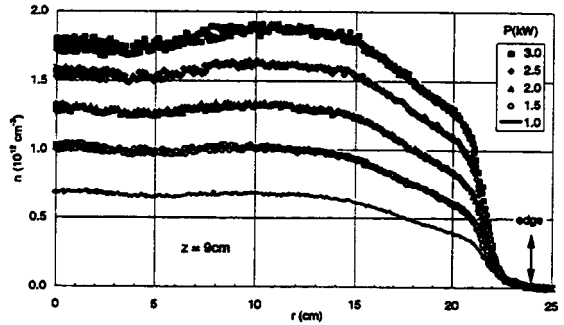

Fig. 17a

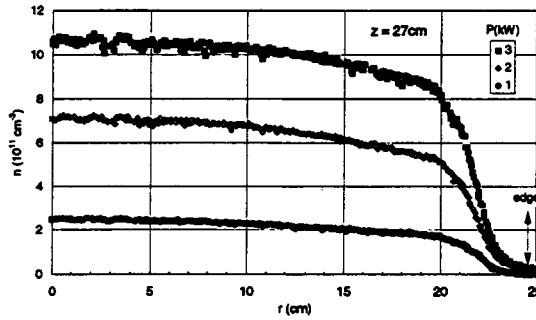
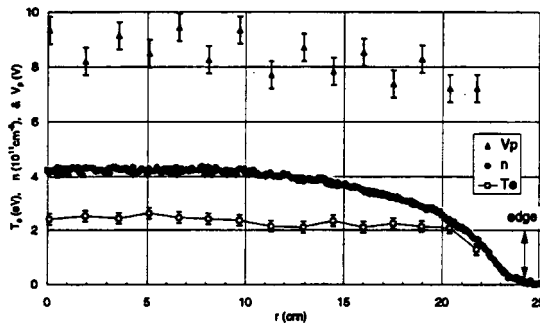

Fig. 17b

Temperature, density, and plasma potential profiles were also measured using an RF-compensated **Langmuir** probe in a Cl_2 plasma. Results are shown in Fig. 18.

Fig. 18: 3mTorr Cl_2 , 3kW, 35G, $z = 27\text{cm}$, $N = 2$

Azimuthal symmetry in this device was measured with a new lazy susan probe with smaller ion collectors and an overall diameter covering the 18" diam chamber. In Fig. 19 the ion flux at each radius is normalized to a circle of that radius. In this run, only the six outer tubes were energized. The outermost data at $r = 14\text{cm}$ were uniform to $\pm 5\%$.

5. Summary and acknowledgments

Multi-tube discharges can be made to operate in the high-density helicon mode by imposing a large scale magnetic field which falls off slowly enough away from each source that the downstream density peak, characteristic of helicon discharges, has a chance to form.

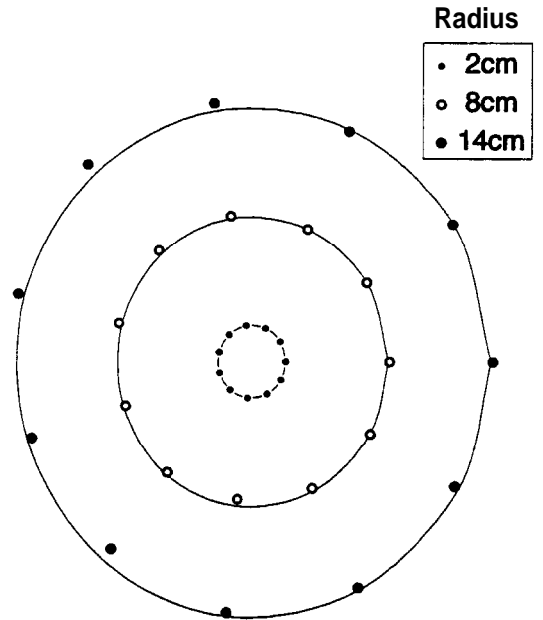
Fig. 19: 15mTorr Ar, 80G, 1.4kW, $N=4$, $z = 30\text{ cm}$

By using large, opposing field coils as in the **Trikon MØRI**® source, the coil current ratio can be used to control the density profile for different process gases. Individual solenoids around each tube give no advantage over **ICPs**. It is found that $m = 0$ **antennas** and short discharge tubes give **almost** as good results as longer $m = 1$ helical **antennas**, leading to a more compact source. Even without optimizing the source positions and diameters, plasma densities of or $\approx 2 \times 10^{12}\text{ cm}^{-3}$ uniform over an area $>400\text{mm}$ in diameter have been demonstrated with only 10-20 cm of diffusion length between the sources and the wafer. This concept can lead to the design of robust plasma sources covering circular or rectangular areas of arbitrary size.

The authors are indebted to Dr. George Tynan of Trikon Technologies, Inc., for participation in the experiment and use of his facilities. This work was partially supported by the Semiconductor Research Corporation under project 95-U-529.